



Icematic introduces a new dispenser line, the DI SERIES, which includes two models: DX35, vertical gourmet ice dispenser and TD130 for cubelet shaped ice

COUNTER MODEL

Self contained cubelet ice dispenser.

Up to 115kg production per 24/hr of nugget ice.

5kg storage bin.

Ice and Water push button configuration.

10 AMP power supply.



ICE PRODUCTION

Air Cooled Unit

Air Temp.	Water Temperature			
				
°C / °F	32° / 90°	21° / 70°	15° / 60°	10° / 50°
10° / 50°	119	127	131	135
21° / 70°	103	111	115	119
32° / 90°	78	86	90	94
38° / 100°	70	78	82	86

CUBE TYPE

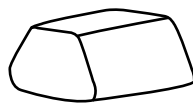

1g

CUBELET ICE

16mm x 15mm x 8mm

CONTROL PANEL





BIN CAPACITY

5 Kg

DIMENSIONS

W x D x H (mm)

 390 x 660 x 880

 460 x 730 x 1070





OPERATING REQUIREMENTS











220-240/50/1



R404a

MIN		MAX
10°C (50°F)		40°C (104°F)
5°C (41°F)		35°C (95°F)
- 10 %		+ 10 %
1 Bar (14 psi)		5 Bar (70 psi)

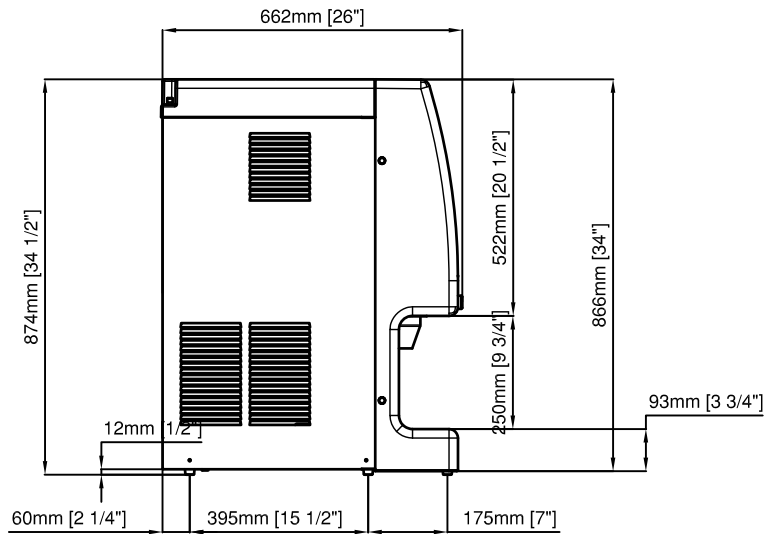
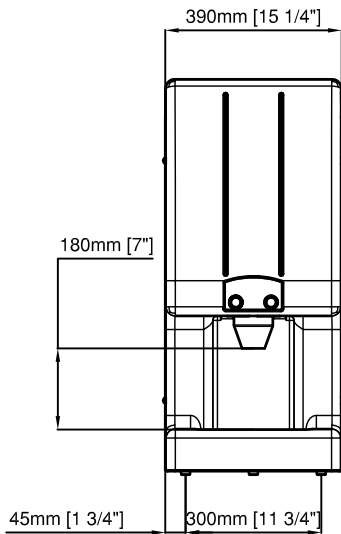

SPECIFICATIONS

	 cond	 comp. W	 ABS. W	 Fuse	 kWh/100kg	 L / hr	 kg	 kg
TD130 A		1200	590	10	14.7	3.6	61	73

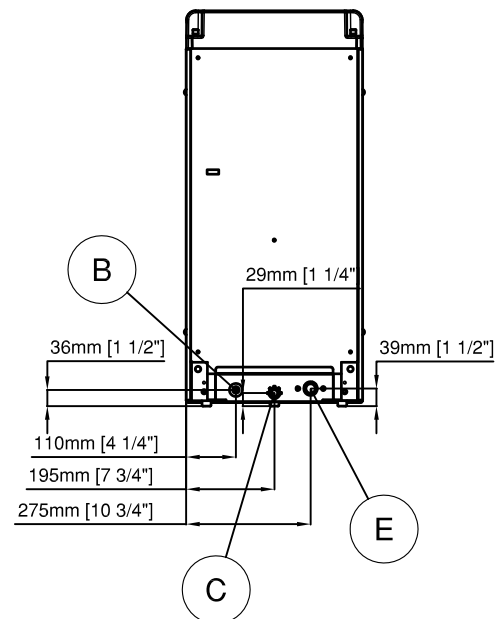
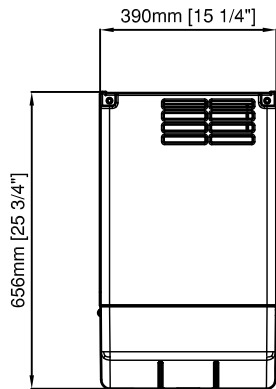

Lateral View
Vista Laterale



-  B Electrical cable supply
-  C Water outlet connection 20mm diam.
-  E Water inlet connection 3/4" gas